

Installation instructions of 4.3/10 type female connector for 1/2" annular cable

43F-LCF12-CP01

ITEM: 2161306.1

Please read the instructions carefully before assembly.

Tools and Material:

Trimming tool (base with separable front end), compression gun, power drill, foam remover, spacer A, depth gauge, cable cutter,

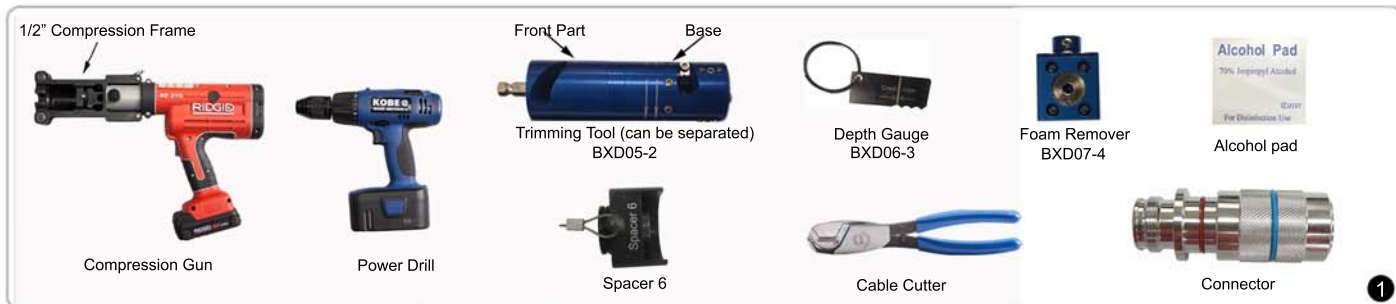

Assembly tools (required).

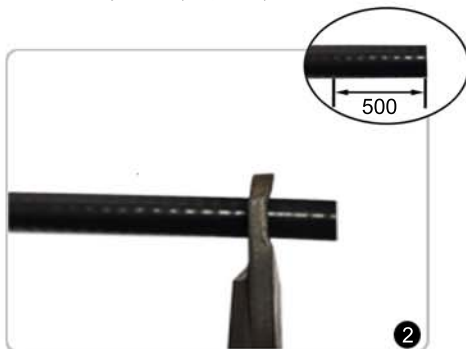

Straighten the first 500mm of the cable, and proceed to cut the cable with cable cutter at the valley (low point) of the corrugation.



Align the end of cable with the end of trimming tool and make two marks on the cable jacket that correspond with lines 1 and 2 on the trimming tool.



Attach the trimming tool to power drill.



Insert the cable into the trimming tool. Select the low speed on the drill or 400~600 RPM on a variable speed drill. Trim the cable until the tool reaches line 1 on the cable.

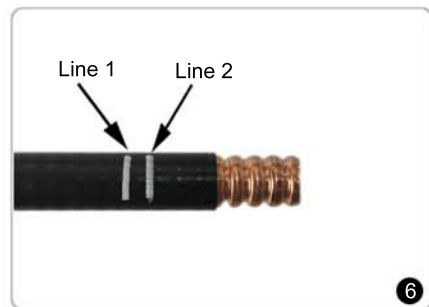

Remove the front part of trimming tool from the base. The base will remain attached to the drill.



Using the low speed setting on the drill, insert exposed outer conductor into trimming tool base. Continue trimming until tool reachscable jacket. Do not push tool beyond this point.

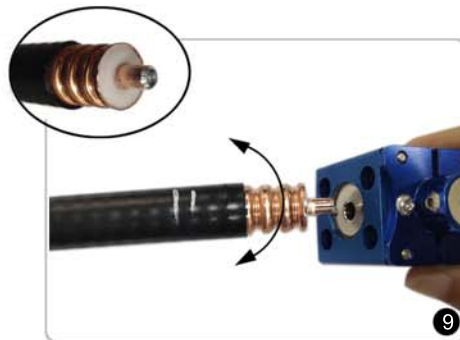

Use the "flat end" of foam remover for outer conductor and dielectric preparation. Rotate back and forth to prepare outer conductor and compact the foam dielectric.

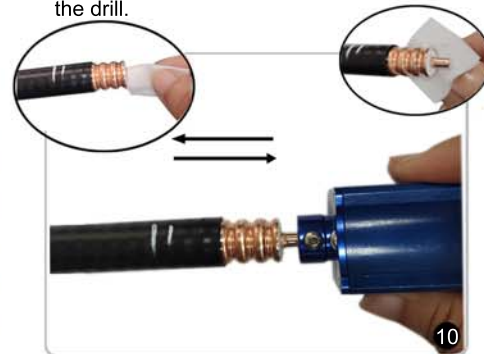

Use the other end of foam remover to remove any dielectric residue from the inner conductor. Clean the inner and outerconductor with alcohol pad.





Installation instructions of 4.3/10 type female connector for 1/2" annular cable

43F-LCF12-CP01

ITEM: 2161306.1

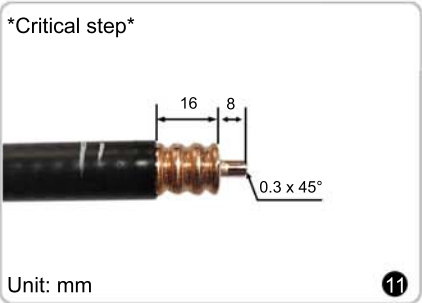

Outer conductor must be prepared to the crest in the corrugation as shown.

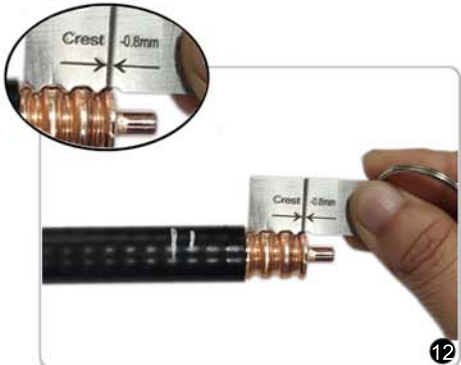

Place the depth gauge on the outer conductor. The crest of the final corrugation should be **within** the area indicated by the depth gauge.

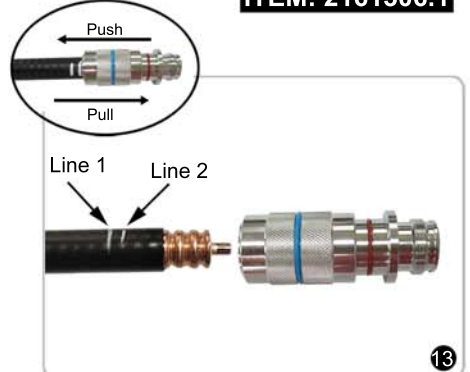

Push the connector onto the cable past Line 2. Then pull the connector to make sure the connector cannot be removed. It will stop just right of Line 2 automatically.

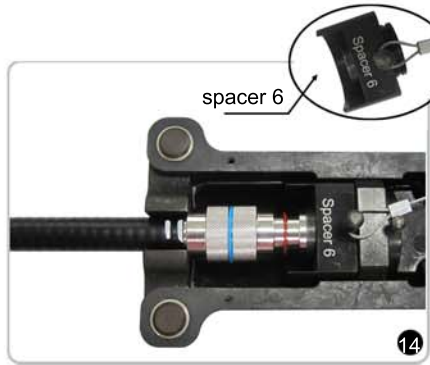

Place spacer 6 into the compression frame. Make sure the connector and cable both lay flat in the compression frame. Make sure the flat side of connector is upwards.



Make sure the connector nut is lined up against spacer 6 to prevent damage to the O-ring during compression.



Press the trigger on the compression gun until it cycles and you hear a "pop". Do not pull or push on compression gun during compression.



Finished.



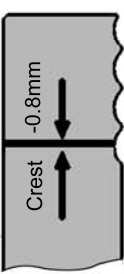

Installation instructions of 4.3/10 type female connector for 1/2" air dielectric cable

43F-LCF12-CP01

ITEM: 2161307.1

Please read the instructions carefully before assembly.

Tools and Material:

Trimming tool (base with separable front end), compression gun, power drill, foam remover, spacer 4, depth gauge, cable cutter,

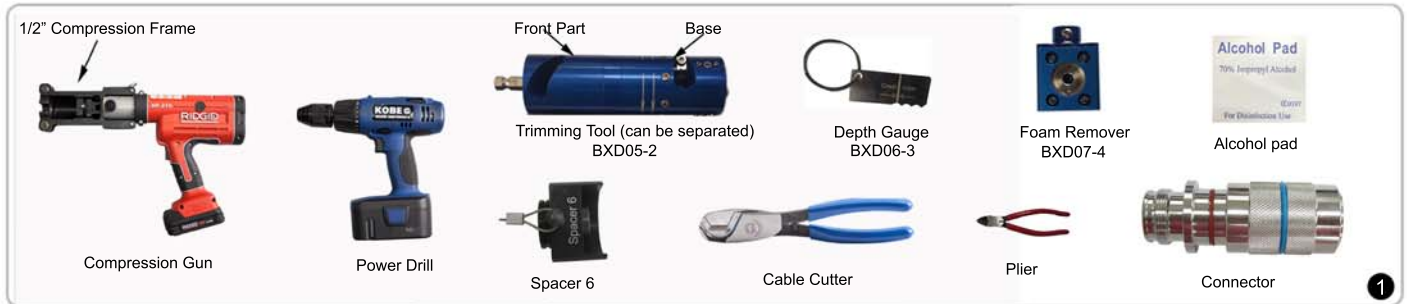

Assembly tools (required).

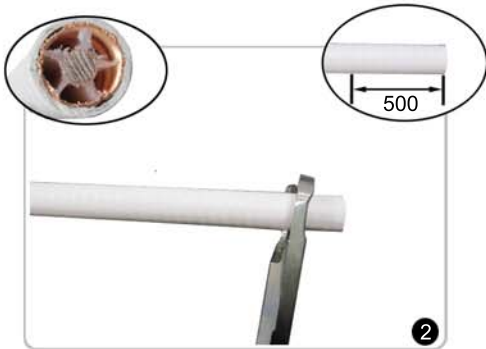

Straighten the first 500mm of the cable, and proceed to cut the cable with cable cutter at the valley (low point) of the corrugation.

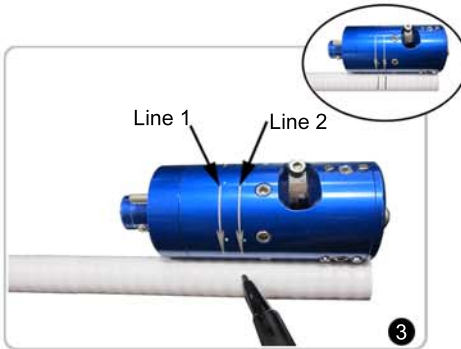

Align the end of cable with the end of trimming tool and make two marks on the cable jacket that correspond with lines 1 and 2 on the trimming tool.



Attach the trimming tool to power drill.



Insert the cable into the trimming tool. Select the low speed on the drill or 400~600 RPM on a variable speed drill. Trim the cable until the tool reaches line 1 on the cable.

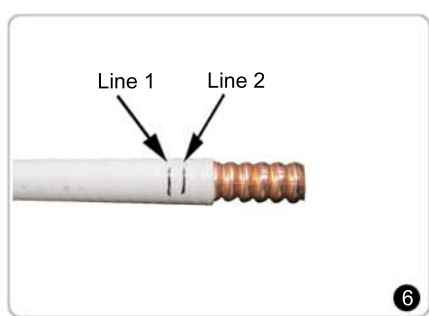

Disassemble the front part from trimming tool. The back part of trimming tool remains assemble to the power drill.



To create the chamfer shown in critical step, push the power drill with back part of trimming tool at low speed or 400 RPM until the leading surface of trimming tool reaches the cable jacket.



To prevent damage to the cable, do not push the trimming tool beyond the end of the cable jacket.



Remove the dielectric wings.





Installation instructions of 4.3/10 type female connector for 1/2" air dielectric cable

43F-LCF12-CP01

ITEM: 2161307.1

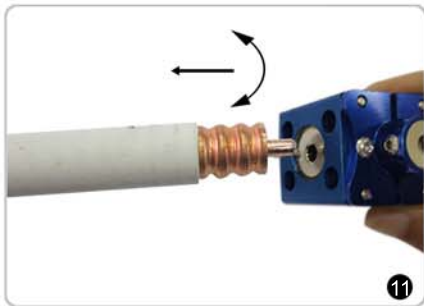

11 Attach the foam remover to the cable. Rotate it in CW/CCW alternately to remove the burrs of the outer conductor.

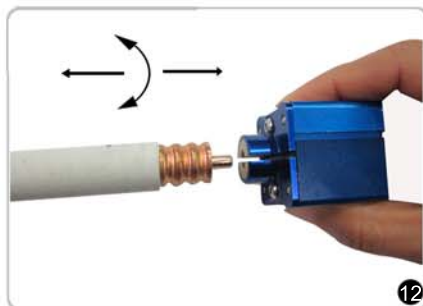

12 Use the foam remover to rotate it in CW/CCW alternately and pull to remove any dielectric residue.

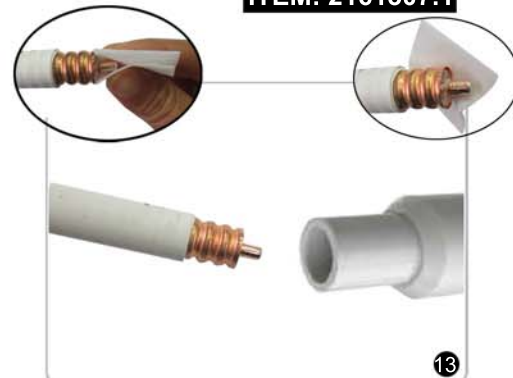

13 Hold cable end at a downward angle, tapping the cable while vacuuming. Clean the inner and outer conductor with alcohol pad.

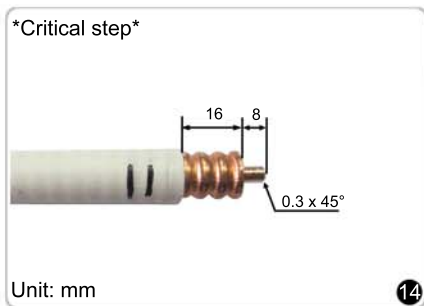

Critical step

Unit: mm

14 Outer conductor must be prepared to the crest in the corrugation as shown.

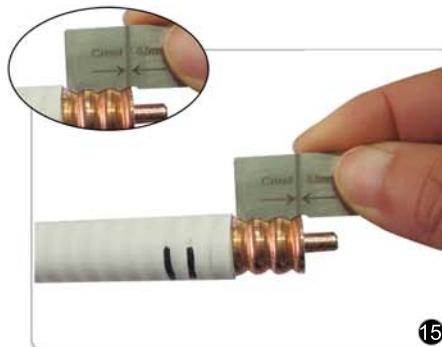

15 Place the depth gauge on the outer conductor. The crest of the final corrugation should be **within** the area indicated by the depth gauge.

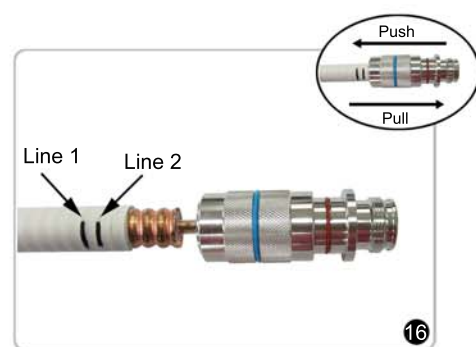

16 Push the connector onto the cable past Line 2. Then pull the connector to make sure the connector cannot be removed. It will stop just right of Line 2 automatically.

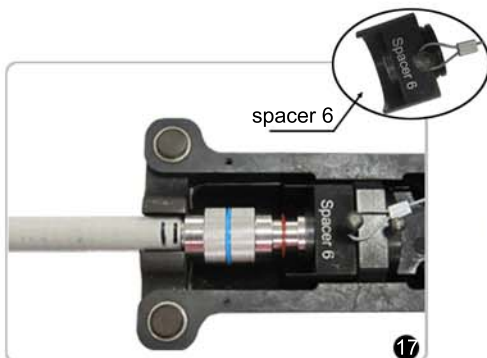

17 Place spacer 6 into the compression frame. Make sure the connector and cable both lay flat in the compression frame. Make sure the flat side of connector is upwards.



18 Make sure the connector nut is lined up against spacer 6 to prevent damage to the O-ring during compression.

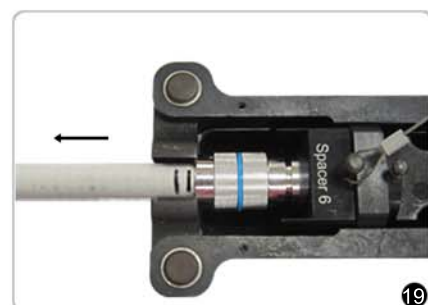

19 Press the trigger on the compression gun until it cycles and you hear a "pop". Do not pull or push on compression gun during compression.



20 Finished.

